

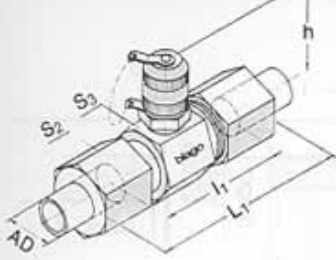

KB&T

— MA 3 —



— MV 3 —

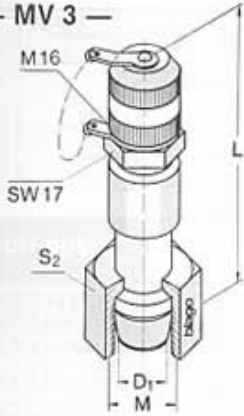

Pressure gauge fitting with screw-lock

Type 3

Pressure gauge connector for cones

series	ND	tube ø D1	L ₁	l ₁	h	S ₃	S ₂	M	L	Blago-No.		
L	250	6	50	20,5	49	24	14	M12 × 1,5	74	MV 3/ 6-L	MA 3/ 6L	
		8	50	20,5	49	24	17	M14 × 1,5	75	MV 3/ 8-L	MA 3/ 8L	
		10	52	22,5	49	24	19	M16 × 1,5	77	MV 3/10-L	MA 3/10L	
		12	52	22,5	49	24	22	M18 × 1,5	77	MV 3/12-L	MA 3/12L	
	160	15	55	24,5	53	30	27	M22 × 1,5	59	MV 3/15-L	MA 3/15L	
		18	56	23,5	54	32	32	M26 × 1,5	61	MV 3/18-L	MA 3/18L	
		22	60	27,5	56	36	36	M30 × 2	63	MV 3/22-L	MA 3/22L	
		28	61	27,5	58	41	41	M36 × 2	64	MV 3/28-L	MA 3/28L	
	100	35	69	25,5	61	46	50	M45 × 2	69	MV 3/35-L	MA 3/35L	
		42	70	24,5	65	55	60	M52 × 2	69	MV 3/42-L	MA 3/42L	
	S	400	6	54	24,5	49	24	17	M14 × 1,5	74	MV 3/ 6-S	MA 3/ 6S
			8	54	24,5	49	24	19	M16 × 1,5	75	MV 3/ 8-S	MA 3/ 8S
10			56	23,5	49	24	22	M18 × 1,5	77	MV 3/10-S	MA 3/10S	
12			56	23,5	49	24	24	M20 × 1,5	77	MV 3/12-S	MA 3/12S	
14			62	26,5	51	27	27	M22 × 1,5	79	MV 3/14-S	MA 3/14S	
16			62	25,5	53	30	30	M24 × 1,5	63	MV 3/16-S	MA 3/16S	
250		20	69	25,5	56	36	36	M30 × 2	68	MV 3/20-S	MA 3/20S	
		25	75	26,5	58	41	46	M36 × 2	70	MV 3/25-S	MA 3/25S	
		30	81	27,5	61	46	50	M42 × 2	73	MV 3/30-S	MA 3/30S	
		38	90	29,0	65	55	60	M52 × 2	77	MV 3/38-S	MA 3/38S	

Pressure gauge connector with screw lock

Male stud pressure gauge connector

Type 3

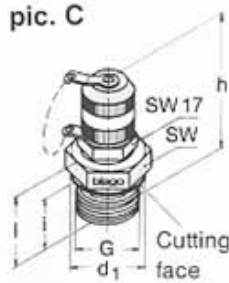
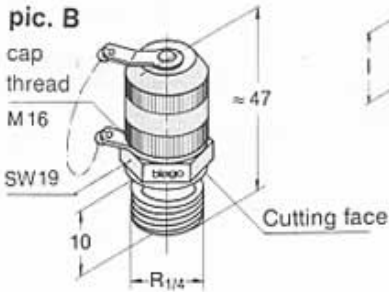
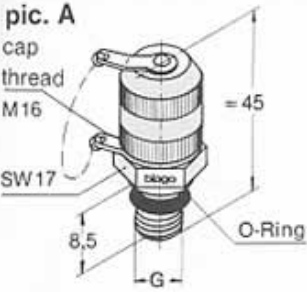

series	ND	G	l	S ₁	l	d ₁	≈ h	pic	Blago-No.				
R	400	R 1/8	8	17	27	14	56	C	MA 3/R 1/8				
		R 1/4	measurements as pic.							B	MA 3/R 1/4		
		R 3/8	12	22	31	22	56	C	MA 3/R 3/8				
		R 1/2	14	27	23	26	46	C	MA 3/R 1/2				
		R 3/4	16	32	26	32	47	C	MA 3/R 3/4				
		R 1	18	41	29	39	48	C	MA 3/R 1				
	250	R 1 1/4	20	50	32	49	49	C	MA 3/R 1 1/4				
		R 1 1/2	22	55	36	56	51	C	MA 3/R 1 1/2				
		M	400	M 8 × 1	measurements as pic.							A	MA 3/M 8 × 1OR
				M 10 × 1	measurements as pic.							A	MA 3/M 10 × 1OR
400	M 10 × 1		8	17	27	14	56	C	MA 3/M 10 × 1				
	M 12 × 1,5		12	17	31	17	56	C	MA 3/M 12 × 1,5				
	M 14 × 1,5		12	19	31	19	56	C	MA 3/M 14 × 1,5				
	M 16 × 1,5		12	22	31	21	56	C	MA 3/M 16 × 1,5				
	M 18 × 1,5		12	24	20,5	23	46	C	MA 3/M 18 × 1,5				
	M 20 × 1,5		14	27	22,5	25	46	C	MA 3/M 20 × 1,5				
200	M 22 × 1,5	14	27	24	27	47	C	MA 3/M 22 × 1,5					
	M 26 × 1,5	16	32	26	31	47	C	MA 3/M 26 × 1,5					
	M 27 × 2	16	32	26	32	47	C	MA 3/M 27 × 2					
	M 33 × 2	18	41	29	39	48	C	MA 3/M 33 × 2					
	M 42 × 2	20	50	32	19	49	C	MA 3/M 42 × 2					
	M 48 × 2	22	55	36	55	51	C	MA 3/M 48 × 2					

Pressure gauge connector and high pressure hose 400 bar max.

Type 3

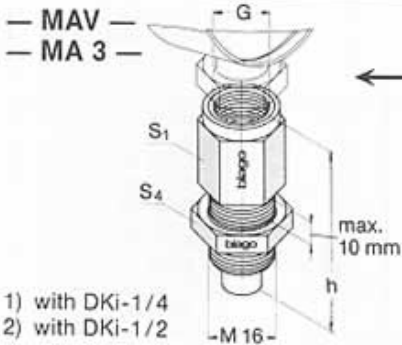

- 1) with DKi-1/4
- 2) with DKi-1/2

series	ND	G	S ₁	S ₄	≈ h	Blago-No.	length	Blago-No.
R	400	R 1/4 ¹⁾	19	22	53	MAV 1/4-MA 3	200	HDS 3- 200
		R 1/2 ²⁾	27	22	65	MAV 1/2-MA 3	300	HDS 3- 300
							400	HDS 3- 400
							630	HDS 3- 630
							800	HDS 3- 800
							1000	HDS 3-1000
							1500	HDS 3-1500
							2000	HDS 3-2000
							2500	HDS 3-2500
							3200	HDS 3-3200
							4000	HDS 3-4000

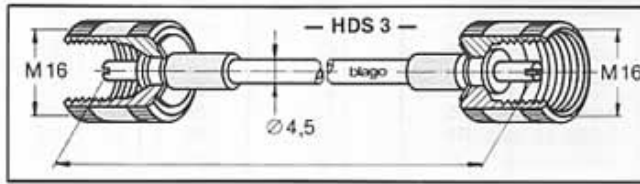

Distributor



KB&T

KB& TRADERS

79/1, APS Complex, Iduvampalayam Road,
Periyandipalayam Tiruppur-641687, India
Mobile: 90477 77573, Tel : 0421 4955647
Email: sales@kbandtraders.com.
Web: www.kbandtraders.com